

Slim, Miniature Relay with 1-pole 5-A Switching Capability

- Slim 5-mm width and miniature size. (20.3 × 5.08 × 12.5 mm max.)
- Ideal for high-density mounting.
- Delivers high switching performance (5 A at 250 VAC/30 VDC) and enables various loads all in a slim, miniature size.
- Highly sensitive coil type (120 mW) also available.
- Satisfies EN 61131-2 (PLC) and EN 61010 (measuring instrument/control equipment) reinforced insulation requirement.
- Special socket also added to the series.



RoHS compliant.

Applications:
PLCs, I/O modules, I/O ports, Timers, Temperature Controllers, and Control Boards.

Ordering Information

Classification	Contact form	Enclosure ratings	Model
Standard	SPST-NO	Fully sealed	G6DS-1A
High-sensitivity			G6DS-1A-H

Note: When ordering, add the rated coil voltage to the model number.

Example: G6DS-1A 12 VDC

Rated coil voltage

Model Number Legend

G6DS - - VDC
1 2 3 4

- | | | |
|---------------------------------|--|--|
| 1. Number of Poles
1: 1 pole | 3. Classification
None: Standard
H: High-sensitivity | 4. Rated Coil Voltage
5, 12, 24 VDC |
| 2. Contact Form
A: SPST-NO | | |

Accessories (Order Separately)

Connecting Socket	P6DS-04P
Relay Pullout Tool	R99-01 for G6DS

Coil Ratings

Item	Standard			High-sensitivity		
	5 VDC	12 VDC	24 VDC	5 VDC	12 VDC	24 VDC
Rated voltage	5 VDC	12 VDC	24 VDC	5 VDC	12 VDC	24 VDC
Rated current	36 mA	15 mA	7.5 mA	24 mA	10 mA	5 mA
Coil resistance	139 Ω	800 Ω	3,200 Ω	208 Ω	1,200 Ω	4,800 Ω
Must operate voltage	70% max. of rated voltage					
Must release voltage	5% min. of rated voltage					
Max. voltage	160% of rated voltage (at 23°C)					
Power consumption	Approx. 180 mW			Approx. 120 mW		

- Note:**
1. The rated current and coil resistance are measured at a coil temperature of 23°C with a tolerance of ±10%.
 2. Operating characteristics are measured at a coil temperature of 23°C.
 3. "Max. voltage" refers to the maximum voltage that can be applied to the relay coil. It is not the maximum voltage that can be applied continuously.

■ Contact Ratings

Item	Resistive load (cos φ=1)	Inductive load (cos φ=0.4, L/R=7 ms)
Rated load	5 A at 250 VAC, 5 A at 30 VDC	2 A at 250 VAC, 2 A at 30 VDC
Rated carry current	5 A	
Max. switching voltage	250 VAC, 30 VDC	
Max. switching current	5 A	
Max. switching power	1,250 VA, 150 W	
Failure rate (reference value) (See note.)	5 mA at 24 VDC	

Note: P level: λ 60 = 0.1 × 10⁻⁶ operation

■ Characteristics

Contact resistance (See note 1.)	100 mΩ max.
Operate time	10 ms max.
Release time	5 ms max.
Insulation resistance (See note 2.)	1,000 MΩ min. (at 500 VDC)
Dielectric strength	3,000 VAC, 50/60 Hz for 1 min between coil and contacts 750 VAC, 50/60 Hz for 1 min between contacts of same polarity
Impulse withstand voltage	6,000 V (1.2 × 50 μs) between coil and contacts
Vibration resistance	Destruction: 10 to 55 to 10 Hz, 0.75-mm single amplitude (1.5-mm double amplitude) Malfunction: 10 to 55 to 10 Hz, 0.75-mm single amplitude (1.5-mm double amplitude)
Shock resistance	Destruction: 1,000 m/s ² Malfunction: 150 m/s ² (standard type). 130 m/s ² (high-sensitivity type)
Endurance	Mechanical: 20,000,000 operations min. (at 18,000 operations/hr) Electrical: 100,000 operations min. (at 1,800 operations/hr) for standard type. 80,000 operations min. (at 1,800 operations/hr) for high-sensitivity type. (at 23°C)
Ambient temperature	Operating: -40°C to 85°C (with no icing)
Ambient humidity	Operating: 5% to 85%
Weight	Approx. 2.3 g

Note: The data shown above are initial values.

1. The contact resistance is possible with 1 A applied at 5 VDC using a fall-of-potential method.
2. The insulation resistance is possible between coil and contacts and between contacts of the same polarity at 500 VDC.

Engineering Data

Maximum Switching Power

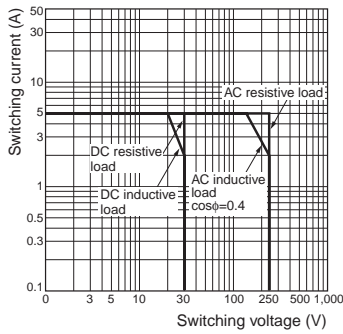

Endurance

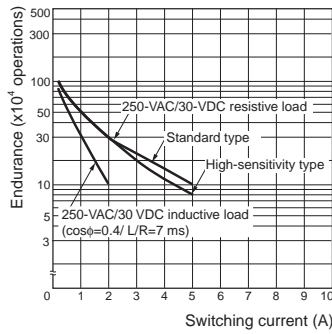

Ambient Temperature vs. Maximum Coil Voltage

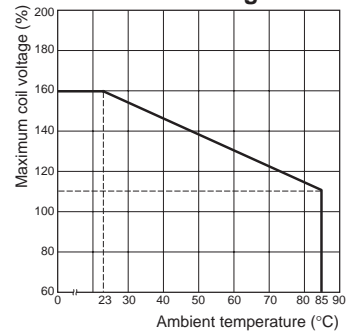

Note: The maximum coil voltage is the maximum voltage that can be applied to the relay coil.

Ambient Temperature vs. Operating/Recovery Voltage G6DS-1A

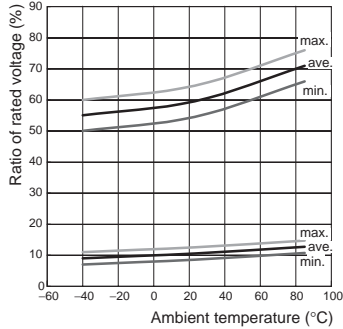

Malfunctioning Shock G6DS-1A

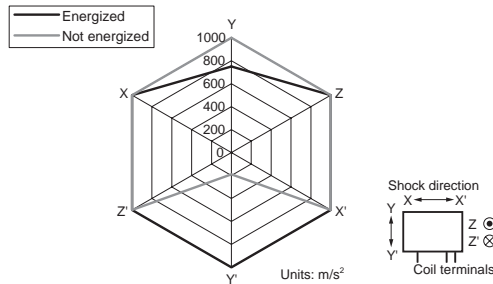

Measurement conditions: Impose a shock in the ±X, ±Y, and ±Z directions three times each with the Relay energized to check the shock values that cause the Relay to malfunction.

■ Approved Standards

• The rated values approved by each of the safety standards may be different from the performance characteristics individually defined in this catalog.

UL 508 (File No. E41515)/CSA C22.2 No.14 (File No. LR31928)

Model	Contact form	Coil ratings	Contact ratings
G6DS-1A	SPST-NO	5 to 24 VDC	5 A, 250 VAC (Resistive & General Use)
G6DS-1A-H			5 A, 30 VDC (Resistive & General Use)
G6DS-1A-H	SPST-NO	5 to 24 VDC	5 A, 250 VAC (Resistive & General Use)
G6DS-1A			5 A, 30 VDC (Resistive & General Use)

VDE (EN61810-1) (License No. B161)

Model	Contact form	Coil ratings	Contact ratings
G6DS-1A	SPST-NO	5, 12, 24 VDC	5 A, 250 VAC (cosφ=1.0)
G6DS-1A-H			5 A, 30 VDC (0 ms)
G6DS-1A-H	SPST-NO	5, 12, 24 VDC	5 A, 250 VAC (cosφ=1.0)
G6DS-1A			5 A, 30 VDC (0 ms)

Dimensions

Note: All units are in millimeters unless otherwise indicated.

G6DS-1A/1A-H

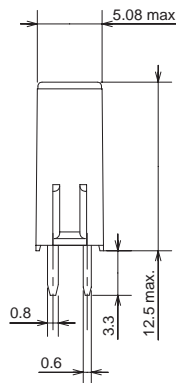
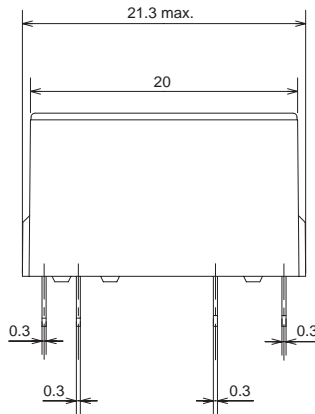

Terminal Arrangement/
Internal Connections
(Bottom View)



Mounting Holes
(Bottom View)

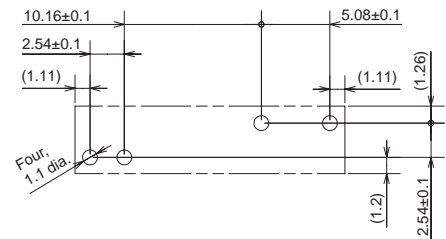

Connecting Socket
P6DS-04P

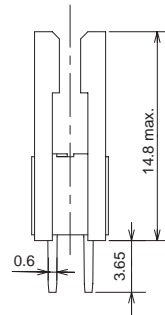
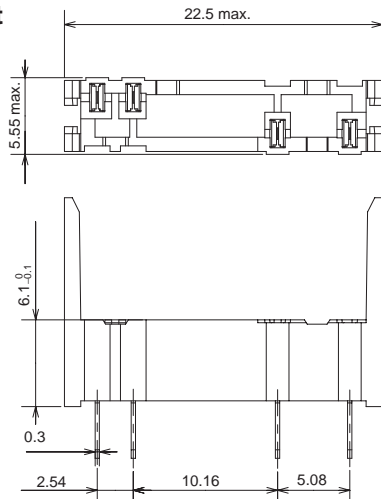
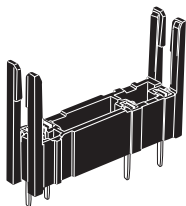

Mounting Holes
(Bottom View)

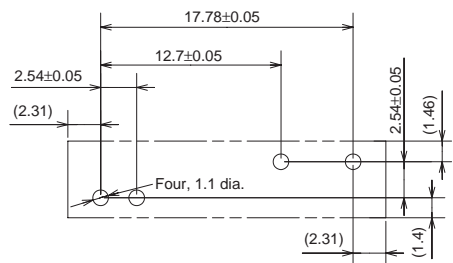

Relay Pullout Tool

R99-01 for G6DS

A convenient removal pullout tool (R99-01 for G6DS) is available to pull Relays out of special sockets mounted closely side by side.

Packing

■ Stick packing

1 stick = 25 Relays
 1 packing case = 20 sticks (500 Relays)
 1 carton box = 6 packing cases (3,000 Relays)

Precautions

More than two Relays can be closely mounted right side up as shown in the following illustration. (This applies to the P6DS as well.)

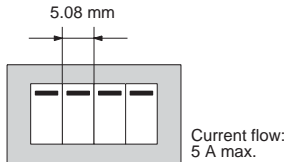

More than two Relays can be closely mounted upside down as shown in the following illustration.

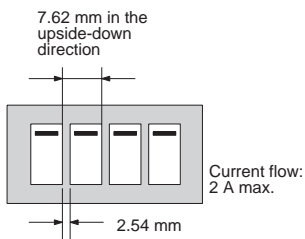

Note: The space between Relays required for heat radiation may vary with operating conditions. Contact your OMRON representative for details.

Socket Mounting Height

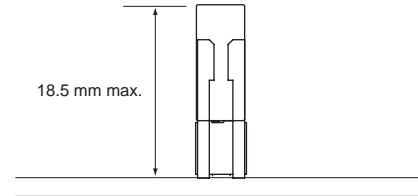

When mounting the Relay, insert it into the Socket as vertically as possible so that the Relay terminals contact securely with the contact pins on the Socket.

The P6DS is flux-resistive. Do not wash the P6DS with water. Dismount the Relay from the Socket before soldering the Socket to a PCB.

Disclaimer:

All technical performance data applies to the product as such; specific conditions of individual applications are not considered. Always check the suitability of the product for your intended purpose. OMRON does not assume any responsibility or liability for noncompliance herein, and we recommend prior technical clarification for applications where requirements, loading, or ambient conditions differ from those applying to general electric applications. Any responsibility for the application of the product remains with the customer alone. THIS COMPONENT CAN NOT BE USED FOR AUTOMOTIVE APPLICATIONS.

ALL DIMENSIONS SHOWN ARE IN MILLIMETERS.

To convert millimeters into inches, multiply by 0.03937. To convert grams into ounces, multiply by 0.03527.

Cat. No. K130-E1-02 **In the interest of product improvement, specifications are subject to change without notice.**

OMRON RELAY & DEVICES Corporation

C & C Power Relay Division
 Marketing Department

1110 Sugi, Yamaga-city, Kumamoto-Pref., 861-0596 Japan
 Tel: (81)968-44-4160/Fax: (81)968-44-4107

Printed in Japan
 0206-?M (0705) (B)